

The Leader In Opening Glass Walls



Tucker's Point Beach Club, Bermuda
NanaWall Folding System **SL72**
Architect: NCG Architects

The NanaWall® is an operable glass wall system custom designed for large openings. The elegant, precision-engineered NanaWall meets the most challenging architectural specifications.

The custom made NanaWall is available in aluminum, wood or clad frames with a selection of over two hundred colors. Independent testing confirms that many NanaWall systems meet or exceed industry standards for air infiltration, water penetration, structural & thermal performance and forced entry.

Enjoy the best of both worlds: a room with a view that opens to the outdoors yet gives you the peace of mind only a weathertight NanaWall provides.

800.873.5673

nanawall.com

NanaWall®
Grand Transformations

Create Large Inviting Entrances



Vertigo Restaurant, New York, NY NanaWall Individual Panel Sliding System **HSW65** Architect: Grade Architecture



Manhattan Motors, Westhampton Beach, NY
NanaWall Miami Dade County Hurricane Approved Folding System **SL72**
Architect: Shawn Leonard Architects



Santa Fe Restaurant, Germany
NanaWall Folding System **SL70**

Invite the Outdoors Inside



Malibu Residence, Malibu, CA NanaWall Folding System **SL45**



Italy Spa
NanaWall Segmented Folding System **SL70**



Coronado Community Center, Coronado, CA NanaWall Folding System **WA67**
Architect: Rossetti Jorgensen

800.873.5673

nanawall.com

NanaWall®
Grand Transformations

Flexible Use of Space



Drake High School, San Anselmo, CA NanaWall Folding System **SL70**
Architect: Deems Lewis McKinley Architects



Seattle Street of Dreams 2005, Woodenville, WA NanaWall Folding System **WD66**
Architect: Curtis Gelotte Architects



St. Kathryn's Church, NH
NanaWall V-shaped Individual Panel Sliding System **HSW65**
Architect: Keefe Associates

Enhance Beautiful Views



The Lift Bar & Grill, Vancouver, BC NanaWall Folding System **WD65**
Architect: Downs / Archambault & Partners



Miami Coastal Residence, Hibiscus Island, FL NanaWall Miami Dade County Hurricane Approved Folding System **SL72** Architect: Beilenson Gomez Architects



Tower 23 Restaurant, Pacific Beach, CA NanaWall Folding System **SL45**
Architect: Graham Downes Architecture, Inc.

Clean Design Lines



Pacific Palisades Residence, CA NanaWall Folding System **SL45** Architect: Cory Buckner, AIA

- All panels are in the same plane in a single track.
- Hinges, sliding/folding and multi-point locking hardware are concealed and integrated into the profiles.
- The sleek lines allow glass areas to be maximized.



Broadmoor Hotel, Colorado Springs, CO NanaWall Folding System **WD65**
Architect: CSNA Architects



Courtyard green-designed House, Los Angeles, CA NanaWall Folding System **WD65**
Ripple Design

Peace of Mind of a Weather-tested NanaWall



Rocky Mountain Residence, Park City, UT NanaWall Folding System **WA67** Architect: Bridgwater Consulting Group

Weather-resistant when closed



Promontory Club, Park City, UT NanaWall Individual Panel Sliding System **HSW50**
Architect: B3 Architects



Snow Country Residence, Germany NanaWall Folding System **SL70**

800.873.5673

nanawall.com

NanaWall®
Grand Transformations

Long-term Satisfaction of the Superior Engineered NanaWall

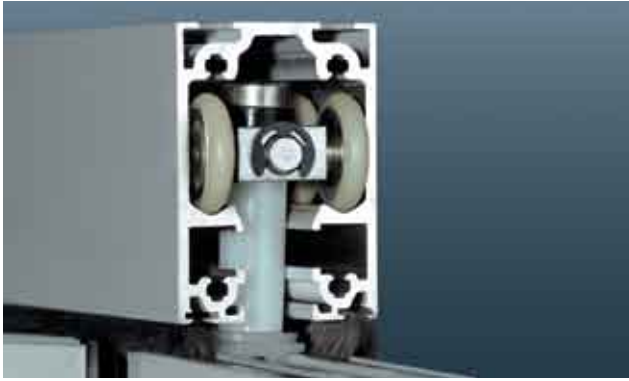

Patented twin, independent-axle running carriage with polyamide rollers provide smooth operation on top-mounted systems and no "flat tire" effect if doors remain closed for long periods.



Special dual stainless steel runners and tracks for floor mounted systems prevent wear and tear and are not affected by debris in the track.



Built in adjustment and compensation points insure continued ease of operation if building settling occurs.



Concealed hinges ride in a secure track on the spine of wood panels providing full adjustability and overall system stability. Note the double gaskets for weather-tight comfort.

Only the NanaWall operable door system incorporates exclusive SolarLux Technology from Solarlux GMBH of Germany, the world leader in opening glass walls. The NanaWall with Solarlux Technology is the product of more than 20 years of research and development backed by rigorous field and lab testing in the US and Europe. NanaWall's unique, patented Solarlux Technology hardware is engineered for long-term smooth operation and quantifiable weather resistance. See the difference in each custom built system. Experience the difference precision Solarlux Technology engineering brings to every detail.

NanaScreen

Introducing the premier operable insect screen system. Now customized and configured exclusively for the NanaWall.

The NanaScreen is a series of collapsible pleated screen panels riding on a single 1/4" high floor track. Each four inch wide vertical cassette can expand to 3 feet 3 inches of reinforced pleated screen. Multiple panels are connected to create a very large screened opening up to 10 feet high. NanaScreen has magnetically secured openings wherever desired.

Durable and easy to operate, the NanaWall brings the outdoors in and the NanaScreen keeps insects out!



Wisconsin Residence with NanaScreen, Nanawall Folding System **SL70**

Design Flexibility

Stacking Options

With folding systems, a multitude of stacking configurations, as well as inward or outward opening options, is available. Variations are paired panels and center pivot options. With individual panel sliding systems, hundreds of parking bay layouts are possible.

Operable Doors

With folding systems, a single acting operable door is possible. With individual panel sliding systems, a swing door can be hinged to a side jamb. With the HSW50, a single acting swing panel can be incorporated into a sliding panel.

Sill Options

Different sills are available to meet weather tightness and handicap access requirements.

Custom Sizes and Custom Layouts

All NanaWalls are custom sized to meet design criteria. Segmented curves and open corners are possible.

Glazing Area Options

Most commercially available glazing such as insulated Low-e glass can be used with a NanaWall. Custom layouts with horizontal mullions, simulated divided lites, inserts, and high bottom rails are available.

Door Material Options:

- Aluminum: Standard and Thermally Broken. Hundreds of high quality powder coated and anodized finishes are available as well as kynar for the SL45. Thermally broken systems incorporate a polyamide reinforced nylon with glass fibers.
- Wood: Choice of douglas fir, pine, western hemlock, meranti, oak and other selected woods
- Aluminum Clad over Wood: Low maintenance extruded aluminum cladding on the outside and the warmth of wood on the inside.

Hardware Options

Locking choices and custodial hardware are available. Depending on configuration selected, door closers and panic devices can be used to meet ADA and exit requirements.



Park Chalet Restaurant, San Francisco, CA
NanaWall Individual Panel Sliding System **HSW50**
Architect: Heller Manus Architects



The Refuge at Lake Havasu Golf Club, Lake Havasu, AZ
NanaWall Folding System **WA67**
Architect: March & Associates



Texas Conservatory, Houston, TX NanaWall Folding System **WD65**
Architect: Design Build Associates

High Levels of Performance

Many NanaWall systems have been independently tested for water penetration, air infiltration, structural integrity, thermal integrity, acoustical performance, forced entry resistance, missile impact and cyclic pressure.

- The SL60, SL70 and WA67, with very high air, water and structural performances, are well suited for many high rise applications.
- The SL72 is Miami-Dade County hurricane approved
- The SL60, SL70, WD66 and WA67 have been rated, certified and labeled in accordance with NFRC 100 for thermal performance and are Energy Star approved with selected glazing.
- STC ratings are available for the SL60, SL70, WD65 and WD66.

As many factors, such as system, size of panels, direction of swing, configuration, type of sill, etc., can affect performance, please contact Nana Wall Systems for detailed test results.

Depending on the application, Nana Wall Systems offers eight different folding systems and six different individual panel sliding systems to meet weather tightness, thermal performance, structural performance, size, function, stacking and aesthetic requirements.

About NanaWall Systems

In 1989, Nana Wall Systems started to provide a wood framed folding glass wall system. Since then, in partnership with Solarlux of Germany, new systems have been introduced to provide more options and better solutions for the growing market for sophisticated operable glass walls. Today, Nana Wall Systems has architectural sales reps, trained installers and showrooms throughout the US, Canada, Mexico, Central America and the Caribbean.

Functional Selection

NanaWall Folding Systems

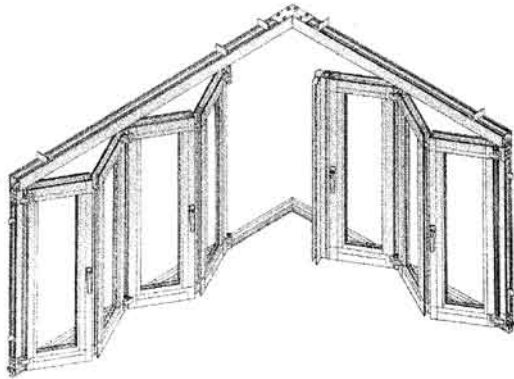

Folding Systems are panels connected together in a train. Panels can be hinged off both side jambs to meet in a number of ways. When open, panels remain 90 degrees to the opening.

Advantages of NanaWall Folding Systems

- With an odd number of panels stacking to one side, a single acting operable door is possible
- Versatile functions with swing enter/exit panel(s) options and with flexibility to fully or partially open.
- Ease of operation to quickly open or close wide openings
- No auxiliary track support is needed as all structural loads are within the plane of the opening.
- Both top supported and floor mounted systems are available
- A multitude of stacking configurations, as well as inward or outward opening options, is available. Variations include paired panels and center pivot options.



Seattle Street of Dreams 2006, Sammamish, WA NanaWall Folding System **WD65**
Architect: Architects Northwest

NanaWall Individual Panel Sliding Systems

Individual Panel Sliding Systems provide the greatest versatility. Each panel is supported by two carriers and is moved independently into position, locking into place with tongue and groove connections.

Advantages of NanaWall Individual Panel Sliding Systems

- Panels can be stacked beyond the plane of the opening and out of sight, such as "pocket" type applications.
- As all the weight is carried by the top track, the floor track does not have a groove or channel.
- Compared to multi track sliders, as all panels are on a single track and in the same plane, greater weather tightness can be achieved and standard wall thickness can be used
- Virtually unlimited number of panels is possible, restricted only by structural constraints.
- With the HSW50, units can include incorporated single acting swing panels. The conversion from swing door to sliding panel is quick and easy.
- With the HSW65, HSW67, VSW35 & VSW65, a swing door can be hinged to a side jamb.



Connecticut Residence, Southport, CT
NanaWall Individual Panel Sliding System **HSW50**
Architect: Raymond Forhand & Associates

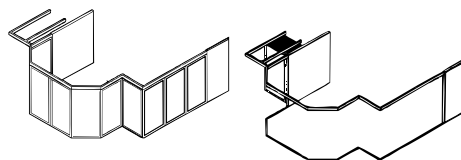

Suitable for complicated openings, any segmented angle between 0° and 90° between flat panels is possible.

Configurations for Nanawall Folding Systems

With NanaWall Folding Systems you can choose from hundreds of configuration options. Shown below are some examples.

The total number of panels in your wall opening depends on your design and the combination of panel height, width and glazing. With a limit of six hinged panels stacking to one side, a maximum width of about

36' is recommended for exterior applications and about 40' for interior applications. With top-hung systems—with additional unhinged paired panels—the maximum number of panels and width is virtually unlimited.

The Basic Configurations for a 4-panel NanaWall Folding System: (Similar analogs are possible with other number of panels.)

Symmetric Solution

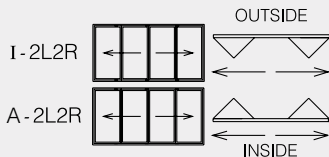

Similar analogs are possible with other numbers of panels.

Pair of Swing Doors Solution

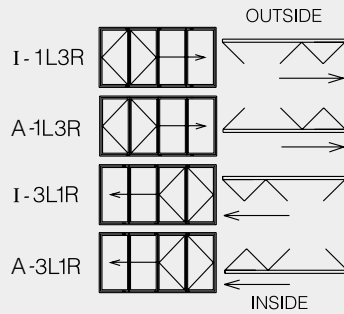

All panels folding to one side

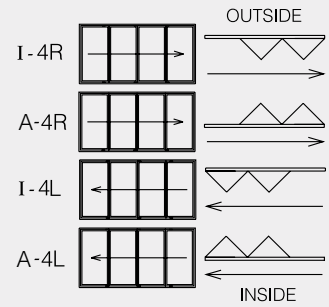

MODEL:

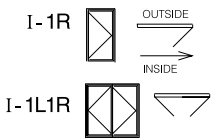

Here are some inward opening configurations with most panels folded to the right. **The exact mirror configurations can be achieved with the majority of panels folded to the left.** The same configurations are also available as outward opening.

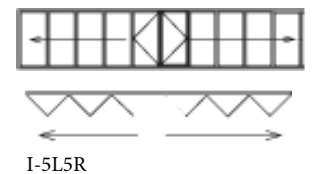
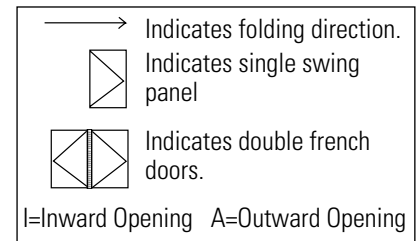
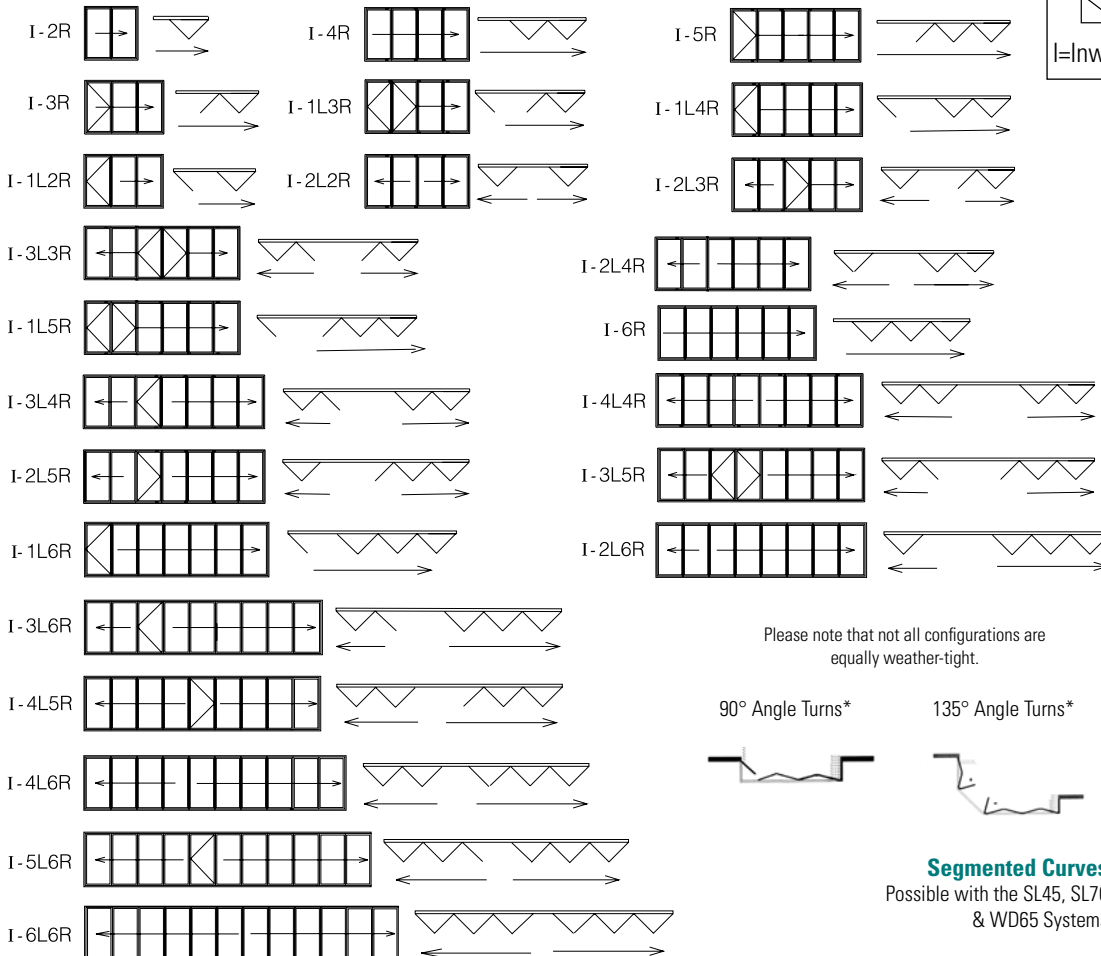

Some Other Examples

Paired Panels

Possible with SL45, WD65 and WA67. Virtually unlimited opening widths are possible.

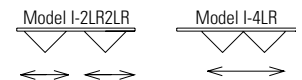

Center Pivot

Possible with the SL45 & WD65 Systems

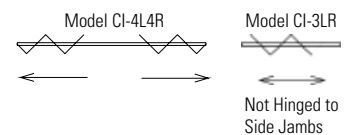

Not Hinged to Side Jamb

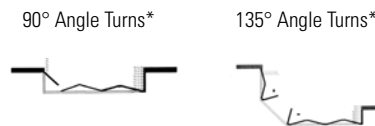

Segmented Curves
Possible with the SL45, SL70 & WD65 Systems

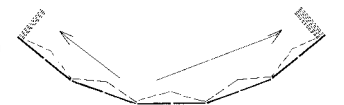

NanaWall Folding Systems—Aluminum Frames

Depending on the application, Nana Wall Systems, Inc. offers five different aluminum profile systems to meet weather tightness, thermal performance, structural performance, size, function, stacking and aesthetic requirements.

SYSTEM	SUPPORT	MAXIMUM PANEL SIZE RANGE ¹	KEY PROPERTIES ²
SL45	Top Hung	3'7" x 8'6" – 2'11" x 9'6"	Monumental top hung system, center pivot, angle changes and segmented curves possible.
SL60	Top Hung or Floor Mounted	3'3" x 7'10" – 2'3" x 9'2"	Thermally broken system, very high weather testing results with the Raised Sill (inswing tested to 15 psf), NFRC certified, Energy Star-rated, STC ratings available. Suitable for residential and highrise applications.
SL70	Floor Mounted	3'7" x 7'10" – 2'3" x 9'6" 3'7" x 9'2" – 3' x 12'2" ³	Thermally broken system, very high weather testing results with the NanaWall Raised Sill (inswing tested to 12 psf), 90° angle changes possible, suitable for highrise applications. NFRC certified, STC ratings and Energy Star ratings available. AAMA Hurricane tested with impact glass.
SL72	Floor Mounted	3'7" x 7'10" – 2'3" x 9'6"	Dade County, Florida State hurricane approved system, vandal resistant.
SL35	Top Hung	3'3" x 7'10" – 2'7" x 8'10"	Standard top hung system, primarily residential.

¹ Maximum size depends on the combination of panel height, width and glazing. ² As many factors, such as system, size of panels, direction of swing, configurations, type of sill, etc. can affect performance, please contact NanaWall Systems for detailed test results. ³ With horizontal mullions.



Newport Beach Residence, CA NanaWall Folding System **SL45**



Whitetails Shore Lodge, McCall, ID NanaWall Folding System **SL70**

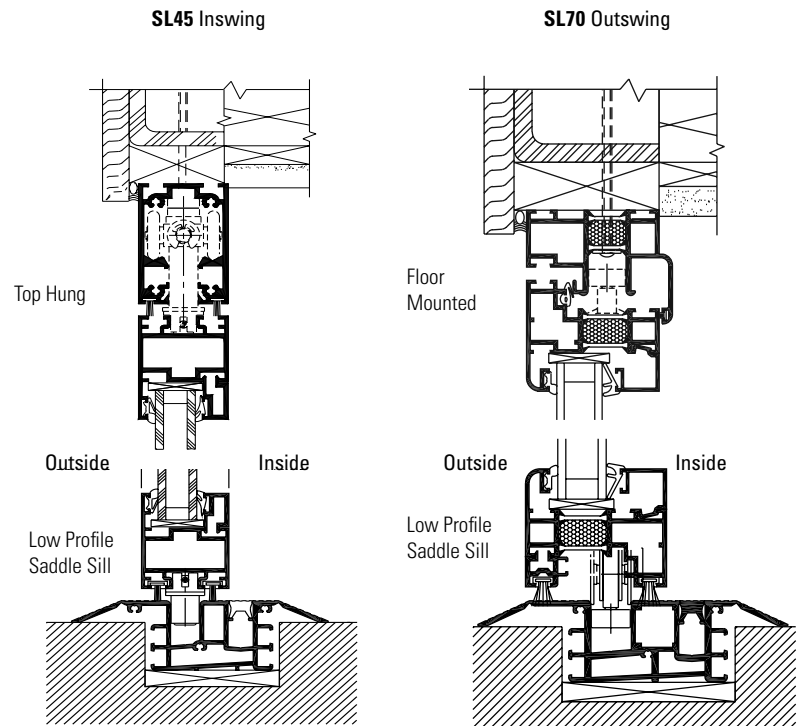

Scale: 1/4" = 1"

NanaWall Folding Systems—Wood and Clad Frames

Depending on the application, Nana Wall Systems, Inc. offers three different wood profile systems to meet weather tightness, thermal performance, structural performance, size, function, stacking and aesthetic requirements.

SYSTEM	SUPPORT	MAXIMUM PANEL SIZE RANGE ¹	KEY PROPERTIES ²
WD66	Top Hung or Floor Mounted	3'3" x 7'10" – 2'3" x 9'2"	90° angle changes possible, very high weather testing results with the Raised Sill (inswing and outswing units tested to 12 psf). NFRC certified, Energy Star rated, STC ratings.
WD65	Top Hung	3'7" x 8'6" – 3' x 10' ³	Center pivot, angle changes and segmented curves possible. STC ratings available.
WA67	Top Hung or Floor Mounted	3'3" x 7'10" – 2'3" x 9'2"	Aluminum on the outside, wood on the inside, very high weather testing results with the NanaWall Raised Sill (inswing and outswing units tested to 12 psf). Suitable for highrise applications. NFRC certified and Energy Star rated.

¹ Maximum size depends on the combination of panel height, width and glazing. ² As many factors, such as system, size of panels, direction of swing, configurations, type of sill, etc. can affect performance, please contact NanaWall Systems for detailed test results. ³ With horizontal mullions.

The **WA67** system combines wood and aluminum. As aluminum and wood expand and contract at different rates; aluminum is attached to wood with spacers so they do not touch directly.

Sunset & Popular Science Idea House with matching transoms above, Alamo, CA
NanaWall Folding System **WA67**
Architect: Dahlin Group Architects



Marina Penthouse, San Francisco, CA NanaWall Folding System **WD66**
William Duff, Architect

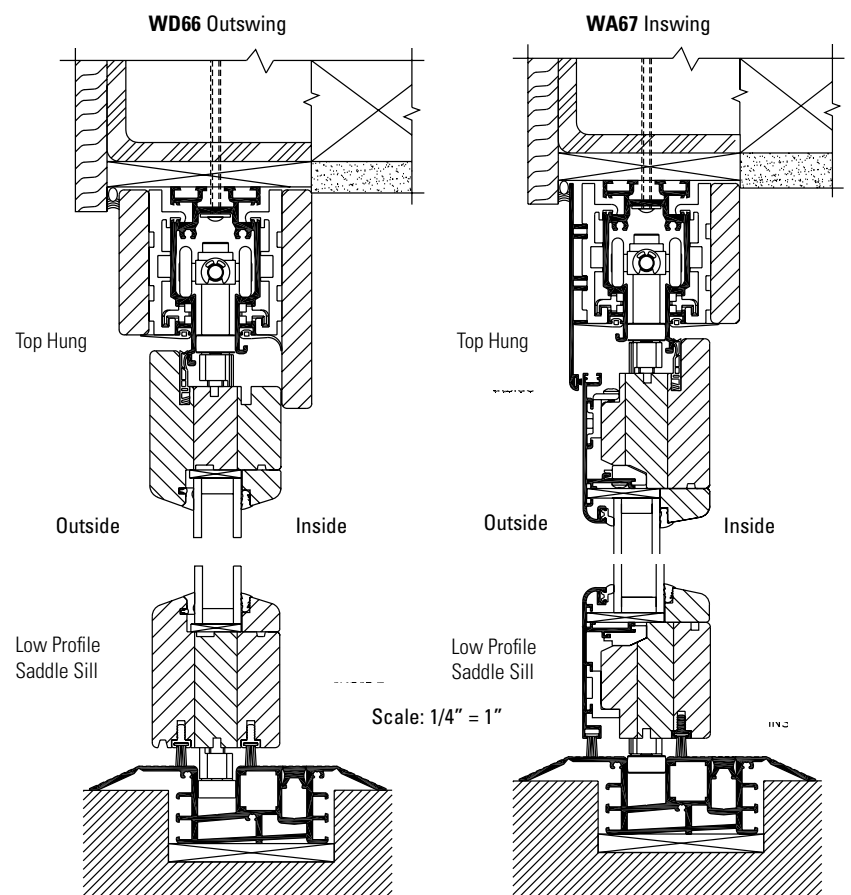
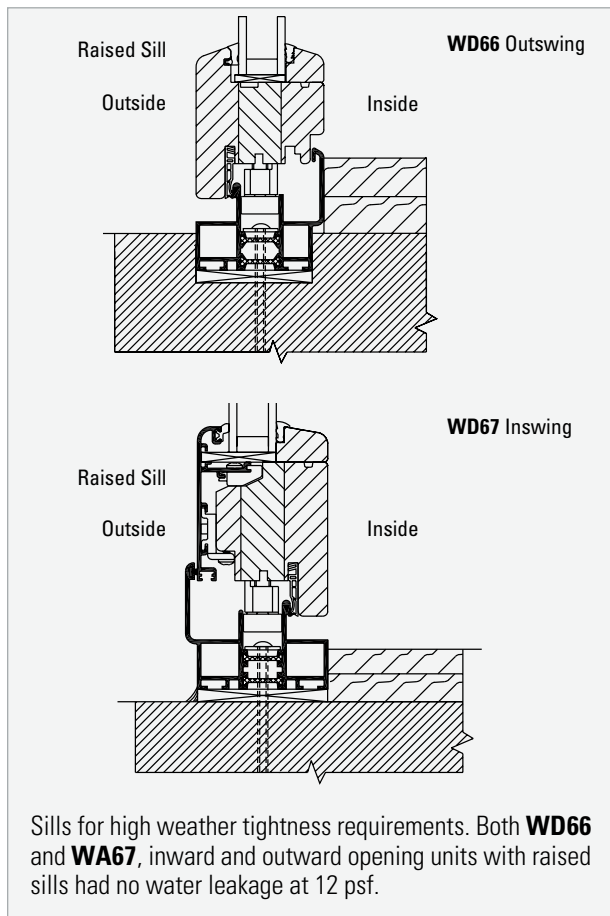

Choices of NanaWall Individual Panel Sliding Systems

NanaWall individual panel sliding systems provide the ultimate in versatility and flexibility. Storefront and entrance systems that can easily be slid away completely out of site when desired. Gain extra space for seating and displays.

Depending on the application, Nana Wall Systems, Inc., offers several different individual panel sliding systems to meet weather tightness, thermal performance, structural performance, size, function, stacking, and aesthetic requirements.

SYSTEM	FRAME	SUPPORT ⁴	MAXIMUM PANEL SIZE RANGE ¹	KEY PROPERTIES ²
HSW50	Aluminum	Top Hung	up to 3'11" x 9'10"	Thermally broken system, incorporated swing doors possible, angle changes and segmented curves possible, unlimited range of stacking options.
HSW65	Wood	Top Hung	up to 3'11" x 9'10" ³	Angle changes and segmented curves possible, unlimited range of stacking options, a swing door can be hinged off a side jamb.
VSW35	Aluminum	Top Hung	3'3" x 8'6" – 3'11" x 7'10"	Ideal for pocket solutions, a swing door can be hinged off a side jamb.
VSW65	Wood	Top Hung	up to 3'11" x 9'10"	Ideal for pocket solutions, a swing door can be hinged off a side jamb.
HSW67	Clad over Wood	Top Hung	up to 3'3" x 8'2"	Aluminum on the outside, wood on the inside. A swing door is needed on the stacking side jamb.
SL25	Glass/Aluminum	Top Hung	1'9" x 8'6" – 2'7" x 6'6"	No vertical frames, for unbroken views, operable balcony and porch enclosure system.

¹Maximum size depends on the combination of panel height, width and glazing. Consult Nana Wall Systems with your size requirements. ²As many factors, such as system, size of panels, direction of swing, configurations, type of sill, etc. can affect performance, please contact Nana Wall Systems for detailed test results. ³With horizontal mullions.

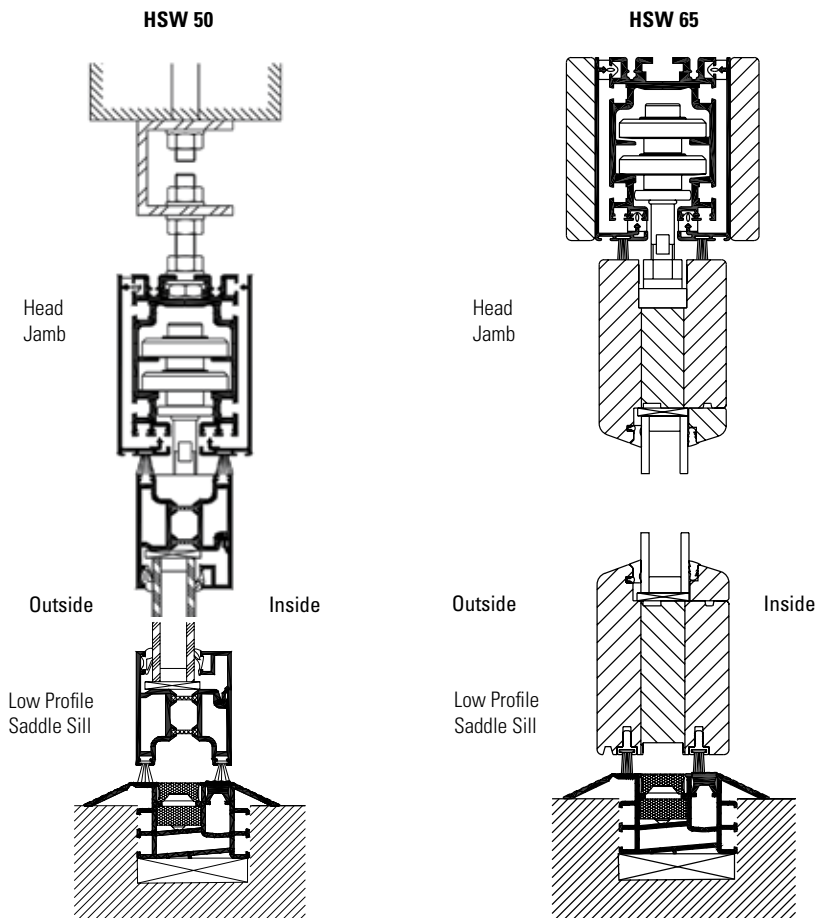

Scale: 1/4" = 1"



Four Food Studio, Melville, NY NanaWall Individual Panel Sliding System **HSW50** Architect: D3 Architecture PC



Wellesley College, Wellesley, MA NanaWall Individual Panel Sliding System **HSW65** Architect: Einhorn Yaffee Prescott



Autzen Stadium sky boxes, University of Oregon, OR NanaWall Individual Panel Sliding System **HSW50** Architect: Ellerbe Becket, MO

Configurations for NanaWall Individual Panel Sliding Systems

Shown below are some basic configurations for NanaWall Individual Panel Sliding Systems. The panels can be stacked visibly or hidden in a wall pocket. A virtually unlimited number of panels is possible. As each wall opening situation is unique, please submit your ideas and sketches to Nana Wall Systems for evaluation.

NanaWall systems HSW50, HSW65, HSW67

With the aluminum framed HSW50, the glass wall can include incorporated single acting swing panels. The conversion from swing door to sliding panel is quick and easy. With the HSW65 and HSW67, a swing door can be hinged to a side jamb.

With an ingenious, variable angle astragal profile, any segmented angle between 0° and 90° between flat panels is possible. See circular HSW50 unit below.



Marin County Hilltop Residence, Mill Valley, CA
NanaWall Individual Panel Sliding System **HSW65**

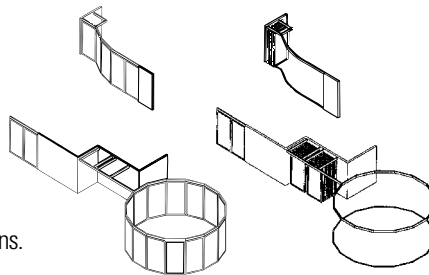

VSW35 and VSW65

The VSW systems are ideal for "pocket" type applications. A swing door can be hinged to a side jamb.

Some possible stacking configurations.

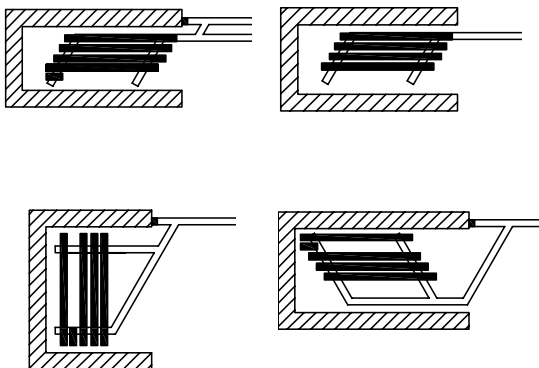

NanaWall Folding System **VSW35**.
Single track pocket slider.

HSW50

Some possible configurations for a five panel unit. Note the number of panels is virtually unlimited.

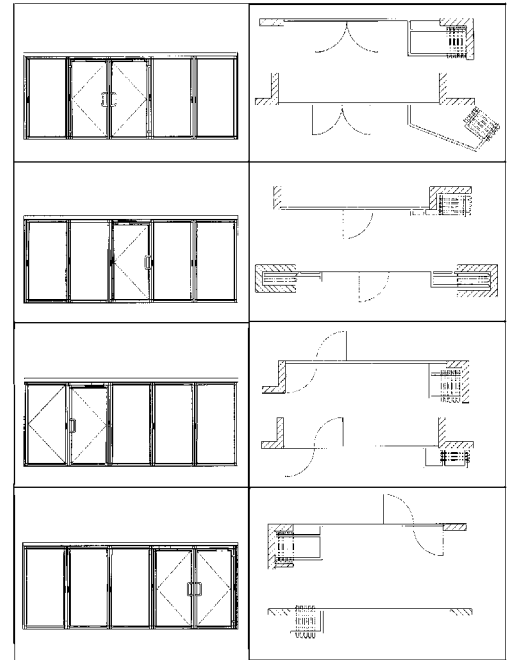

SL25

All glass system for balcony and patio enclosures.



NanaWall All Glass System **SL25**
Glass Room, Germany

Some possible stacking configurations.

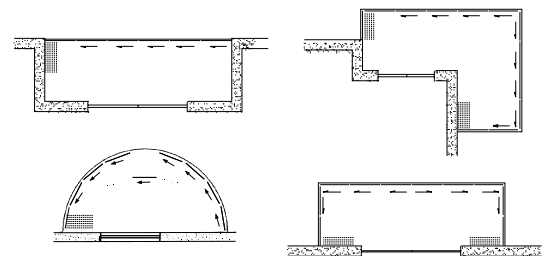



Loblolly House, Taylors Island, MD NanaWall Folding System **SL70** Kieran Timberlake Associates Photography: © Peter Aaron/Esto

Nana Wall Systems, Inc.

Nana Wall Systems is the North American partner of Solarlux, Germany, the world leader in operable glass wall technology.

Please contact Nana Wall Systems for architectural sales representatives, trained installers, and showroom locations.

707 Redwood Highway
 Mill Valley, CA 94941
 (415) 383-3148
 (800) 873-5673
 Fax (415) 383-0312
 E-Mail: info@nanawall.com

Visit our award-winning online design manual: www.nanawall.com

- Thousands of Project Photos
- Animations
- CAD Details
- Specifications
- Test Data



Cannery Loft luxury condominium, Newport Beach, CA Builders Choice Award 2005: Project of the Year NanaWall Folding System **SL35** Architect: Tannerhecht Architecture

- Residential Indoor/Outdoor Living
- Restaurants & Cafés
- Commercial Offices/Banks/Sound Studios
- Hotels/Resorts/Spas
- Retail Storefronts/Malls
- Clubhouses/Community Centers
- Loft Conversions/Interior Space Separations
- Sanctuaries/Reception Halls
- Schools/Libraries/Museums
- Stadiums/Luxury Boxes
- Hospitals/Assisted Living
- Auto Showrooms
- High & Mid-Rises/Condominiums
- Sunrooms/Solariums

©2007 NANA WALL SYSTEMS, INC.
 NANA WALL SYSTEMS reserves the right to change specifications without notice.

800.873.5673

nanawall.com

NanaWall® 

SOLARLUX®
 technology